

BC H9G

A 5 H9F 5 @ \$ " \$ % & " H B ' D @ 5 H 9 8 ' G H 9 9 @ 6 F ≠ < H : B < G <

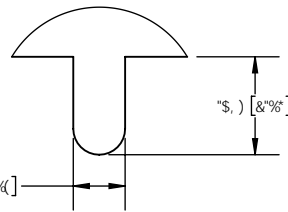

8 9 H 5 @ 5  
G 7 5 @ 9 ' \* : ' %  
D-B ' HMD

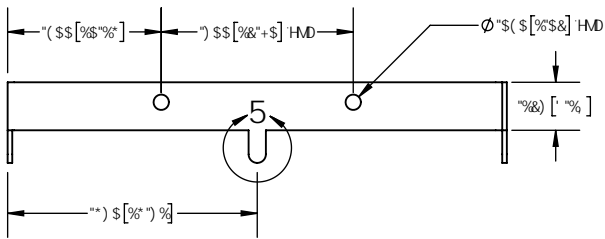
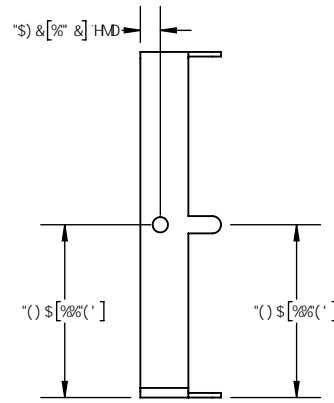
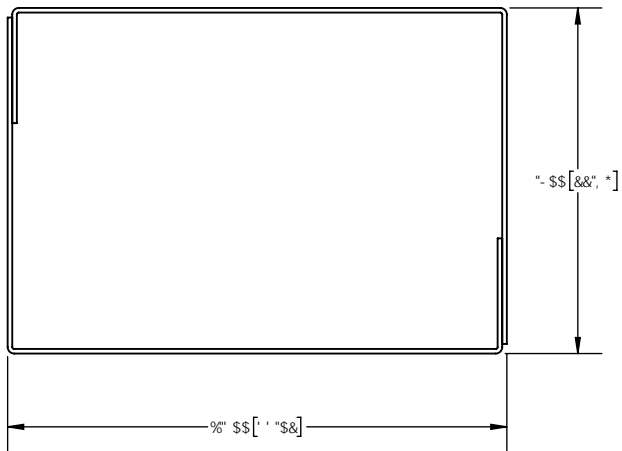
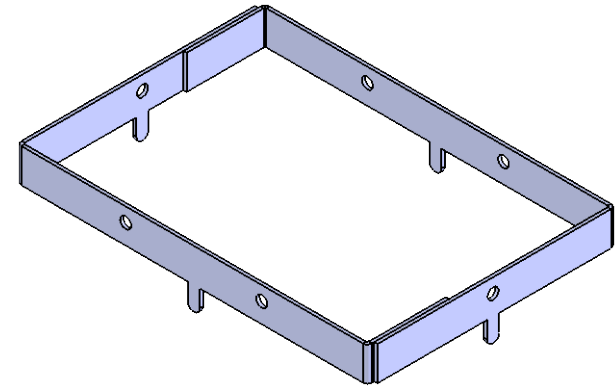
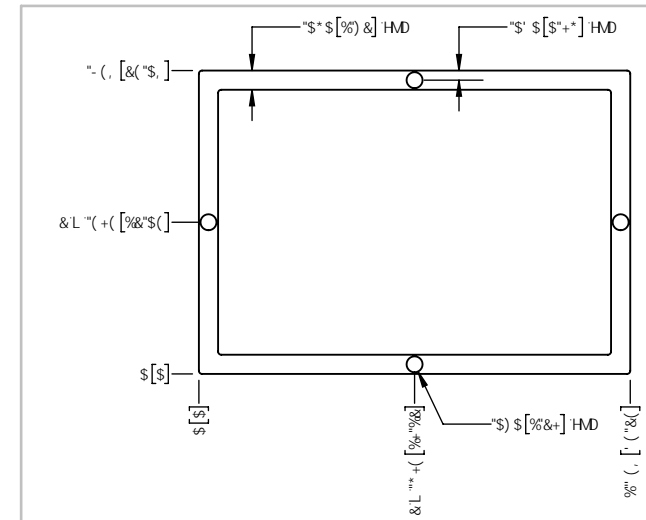

D7 6 : C C H D F - B H

PROPRIETARY NOTICE: THESE DRAWINGS, LISTS OR SPECIFICATIONS ARE THE CONFIDENTIAL INFORMATION AND/OR TRADE SECRETS OF 3GMETALWORX INC., AND ISSUED IN STRICT CONFIDENCE. EXCEPT AS AUTHORIZED BY 3GMETALWORX IN WRITING, THESE DRAWINGS, LISTS OR SPECIFICATIONS SHALL NOT BE REPRODUCED, TRANSMITTED, USED FOR THE DESIGN, MANUFACTURE OR SALE OF EQUIPMENT OR USED FOR ANY OTHER PURPOSE OTHER THAN EVALUATION.

I B @ 9 G C H : 9 K 4 9 9 D 9 7 = 9 6  
I # A ..... H C @ 9 5 B 7 9  
B 7 < 9 G ..... ± \$ \$ \$

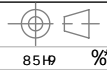

FC < G  
7 C A D 9 6 B 7 9  
8 5 9 9 4 \* # 9 1



D5FHBI A 69F	F 9 1 "
: @ ! G ( \$ &	\$
8 9 9 7 F - D H C B	: @ L
G 7 5 @ 9 & %	G < 9 9 H % C : %

8 5 H 9

% ! \$ % & \*

&

%